

GENERAL DESCRIPTION

The TL431 is a three-terminal adjustable regulator series with a guaranteed thermal stability over applicable temperature ranges. The output voltage may be set to any value between V_{ref} (approximately 2.495 volts) and 40 volts with two external resistors. These devices have a typical dynamic output impedance of 0.2Ω . Active output circuitry provides a very sharp turn-on characteristic making these devices excellent replacement for zener diodes in many applications. The TL431 is characterized for operation from -40°C to $+125^{\circ}\text{C}$.



TO-92



SOT-23

FEATURES

- ◆ Programmable output voltage to 36V
- ◆ Low dynamic output Impedance 0.2Ω .
- ◆ Sink current capability of 1 mA to 100 mA.
- ◆ Equivalent full-range temperature coefficient of $80\text{ ppm}/^{\circ}\text{C}$
- ◆ Temperature compensated for operation over full Rated operating Temperature Range
- ◆ Low output noise voltage . Fast turn on respons.
- ◆ Provided pb-free packages.
- ◆ ESD tolerance (human body model) 2000V.
- ◆ Package outline: TO-92, SOT-23.

Internal Function Block Diagram

FUNCTIONAL BLOCK DIAGRAM

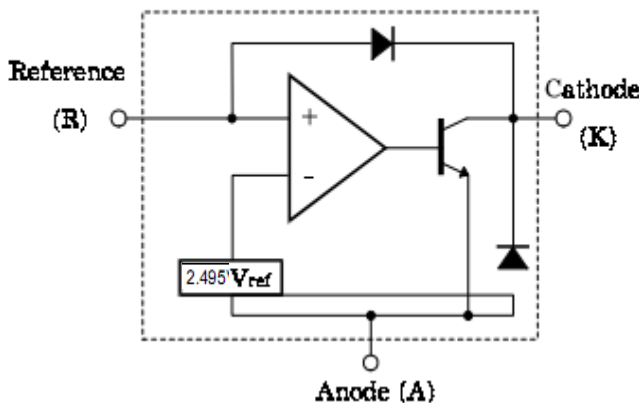

SYMBOL

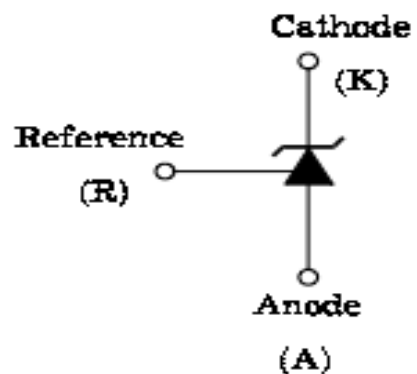

ABSOLUTE MAXIMUM RATINGS

Characteristic	Symbol	Value	Unit
Cathode voltage	V_{KA}	40	V
Cathode current range (Continuous)	I_K	100	mA
Reference input current range	I_{REF}	0.05 ~ 10	mA
Power dissipation at 25°C: TO – 92 Package (RJA = 178°C/W) SOT – 23 Package (RJA = 625°C/W)	P_D	0.7 0.2	W W
Junction temperature range	T_J	0 ~ 150	°C
Operating temperature range	T_g	-40~+125	°C
Storage temperature range	T_{stg}	-65 ~ +150	°C

RECOMMENDED OPERATING CONDITIONS

Characteristic	Symbol	Test Condition	Min	Typ	Max	Unit
Cathode voltage	V_{KA}		V_{REF}		37	V
Cathode current	I_{KA}		0.5		100	mA

TL431- 0.3% ELECTRICAL CHARACTERISTIC (TA=25°C, unless otherwise specified)

CHARACTERISTIC	SYMBOL	CIR-CUIT	TEST CONDITION	MIN.	TYP.	MAX.	UNIT
Reference input Voltage	V_{REF}	1	$V_{KA}=V_{REF}, I_K=10mA$	2.487V	2.495V	2.502V	
Deviation of reference Input voltage over Full temperature range	$\Delta V_{REF}/\Delta T$	1	$V_{KA}=V_{REF}, I_K=10mA$ $T_A=Full\ Range$		3	17	mV
Ratio of change in reference Input voltage to the change in cathode voltage	$\frac{\Delta V_{REF}}{\Delta V_{KA}}$	2	$I_K=10mA$ $\Delta V_{KA}=10V-V_{REF}$ $\Delta V_{KA}=36V-10V$		-1.4 -1	-2.7 -2	mV/V
Reference input current	I_{REF}	2	$I_{KA}=10mA, R1=10K\Omega, R2=\infty$		1.8	4	uA
Deviation of reference input Current Over Full Temperature Range	$\Delta I_{REF}/\Delta T$	2	$I_K=10mA, R1=10K\Omega, R2=\infty$ $T_A=Full\ Range$		0.4	1.2	uA
Minimum Cathode Current for regulation	$I_{KA\ MIN}$	1	$\Delta V_{KA}=V_{REF}$		0.5	1	mA
Off-State Cathode Current	$I_{KA\ OFF}$	3	$V_{KA}=36V, V_{REF}=0$		0.2	1	uA
Dynamic Impedance	Z_{KA}	1	$V_{KA}=V_{REF}, I_K=1mA\sim 100mA,$ $F\leq 1kHz$		0.2	0.5	Ω

TL431-0.5% ELECTRICAL CHARACTERISTIC (TA=25°C, unless otherwise specified)

CHARACTERISTIC	SYMBOL	CIR-CUIT	TEST CONDITION	MIN.	TYP.	MAX.	UNIT
Reference Input Voltage	V _{REF}	1	V _{KA} =V _{REF} , I _K =10mA	2.482V	2.495V	2.507V	
Deviation of Reference Input Voltage Over Full Temperature Range	ΔV _{REF} /ΔT	1	V _{KA} =V _{REF} , I _K =10 mA T _A =Full Range		3	17	mV
Ratio of Change in Reference Input Voltage to the Change in Cathode Voltage	ΔV _{REF} /ΔV _{KA}	2	I _K =10 mA	ΔV _{KA} =10V-V _{REF}	-1.4	-2.7	mV/V
				ΔV _{KA} =36V-10V	-1	-2	
Reference Input Current	I _{REF}	2	I _{KA} =10mA, R1=10KΩ, R2=		1.8	4	μA
Deviation of Reference Input Current Over Full Temperature Range	ΔI _{REF} /ΔT	2	I _K =10mA, R1=10KΩ, R2=		0.4	1.2	μA
Minimum Cathode Current for Regulation	I _{KMIN}	1	ΔV _{KA} =V _{REF}		0.5	1	mA
Off-State Cathode Current	I _{KOFF}	3	V _{KA} =36V, V _{REF} =0		0.2	1	μA
Dynamic Impedance	Z _{KA}	1	V _{KA} =V _{REF} , I _K =1mA~100mA f ≤ 1KHZ		0.2	0.5	Ω

TL431-1% ELECTRICAL CHARACTERISTIC (TA=25°C, unless otherwise specified)

CHARACTERISTIC	SYMBOL	CIR-CUIT	TEST CONDITION	MIN.	TYP.	MAX.	UNIT
Reference Input Voltage	V _{REF}	1	V _{KA} =V _{REF} , I _K =10mA	2.47	2.495V	2.52	
Deviation of Reference Input Voltage Over Full Temperature Range	ΔV _{REF} /ΔT	1	V _{KA} =V _{REF} , I _K =10 mA T _A =Full Range		3	17	mV
Ratio of Change in Reference Input Voltage to the Change in Cathode Voltage	ΔV _{REF} /ΔV _{KA}	2	I _K =10 mA	ΔV _{KA} =10V-V _{REF}	-1.4	-2.7	mV/V
				ΔV _{KA} =36V-10V	-1	-2	
Reference Input Current	I _{REF}	2	I _{KA} =10mA, R1=10KΩ, R2=		1.8	4	μA
Deviation of Reference Input Current Over Full Temperature Range	ΔI _{REF} /ΔT	2	I _K =10mA, R1=10KΩ, R2=		0.4	1.2	μA
Minimum Cathode Current for Regulation	I _{KMIN}	1	ΔV _{KA} =V _{REF}		0.5	1	mA
Off-State Cathode Current	I _{KOFF}	3	V _{KA} =36V, V _{REF} =0		0.2	1	μA
Dynamic Impedance	Z _{KA}	1	V _{KA} =V _{REF} , I _K =1mA~100mA f ≤ 1KHZ		0.2	0.5	Ω

TEST CIRCUITS

Fig.1 Test circuit for $V_{KA}=V_{REF}$ Fig.2 Test circuit for $V_{KA} \geq V_{REF}$ Fig.3 Test circuit for $I_{KA}(\text{Off})$

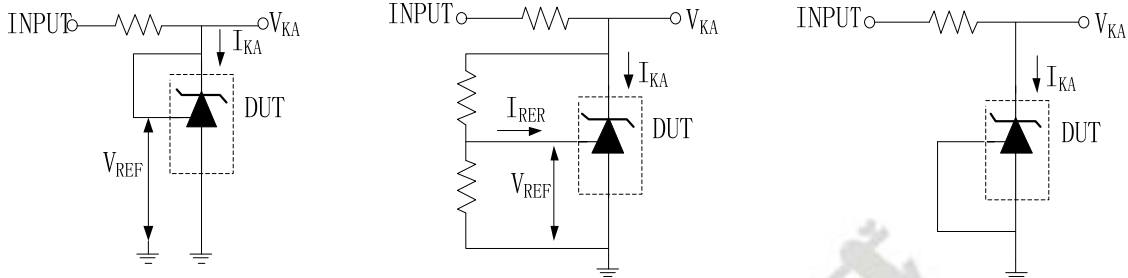

TYPICAL PERFORMANCE CHARACTERISTIC

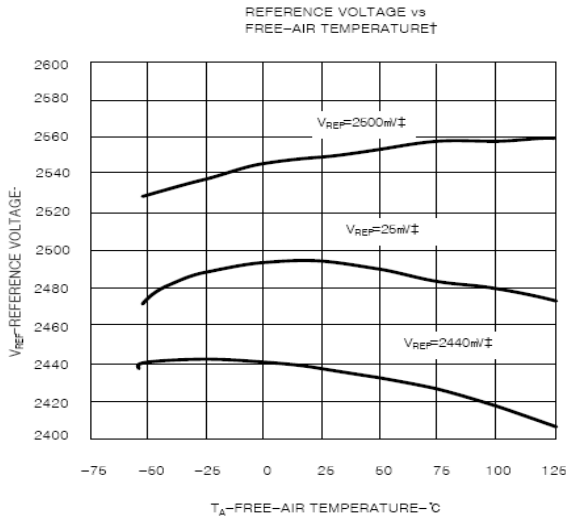

† Data is applicable only within the recommended operating free-air temperature ranges of the various devices.
 ‡ Data is for devices having the indicated value of I_{KA} at $I_{KA}=10\text{mV}$, $T_A=25^\circ\text{C}$

Figure 4.

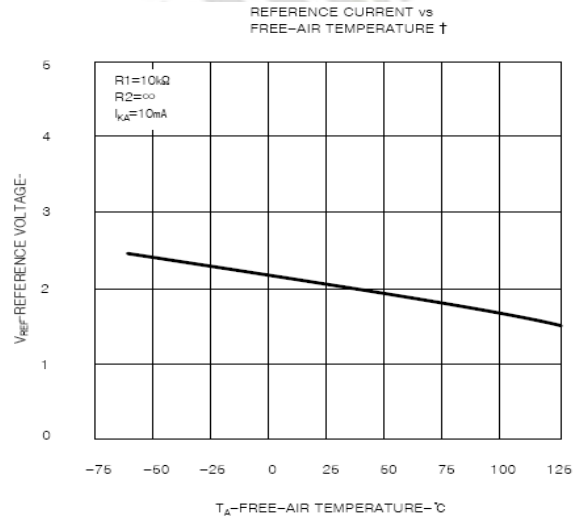

† Data is applicable only within the recommended operating free-air temperature ranges of the various devices.

Figure 5.

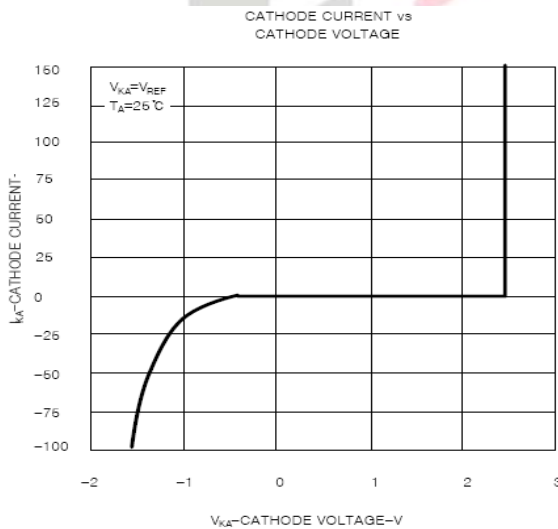

Figure 6.

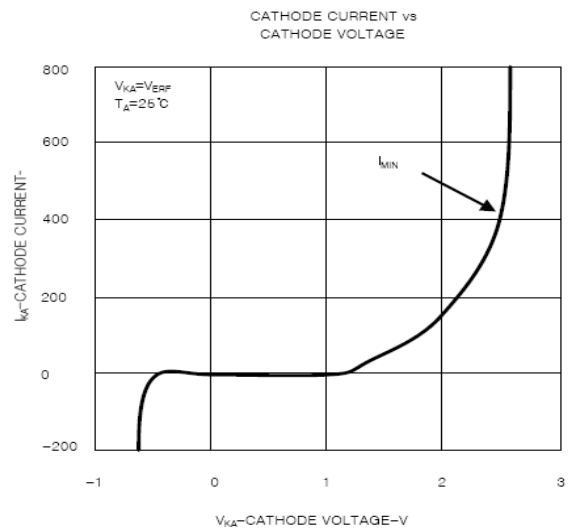
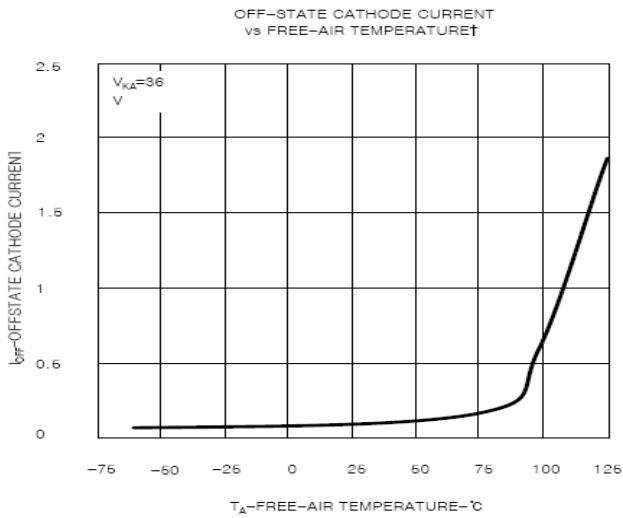
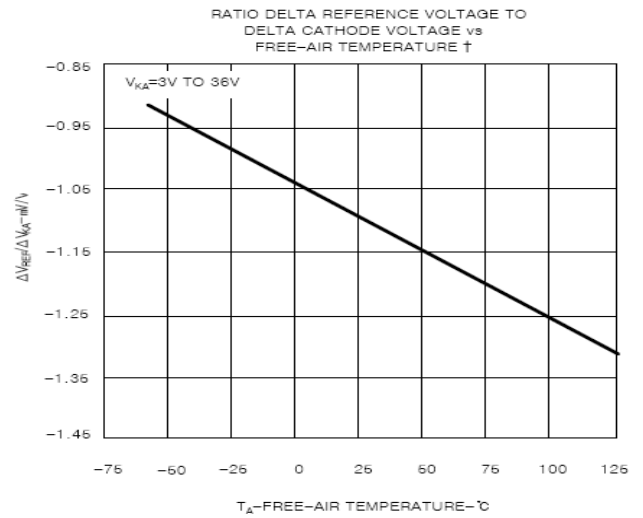

Figure 7.



† Data is applicable only within the recommended operating free-air temperature ranges of the various devices.

Figure 8.



† Data is applicable only within the recommended operating free-air temperature ranges of the various devices.

Figure 9.

EQUIVALENT INPUT NOISE VOLTAGE VS FREQUENCY

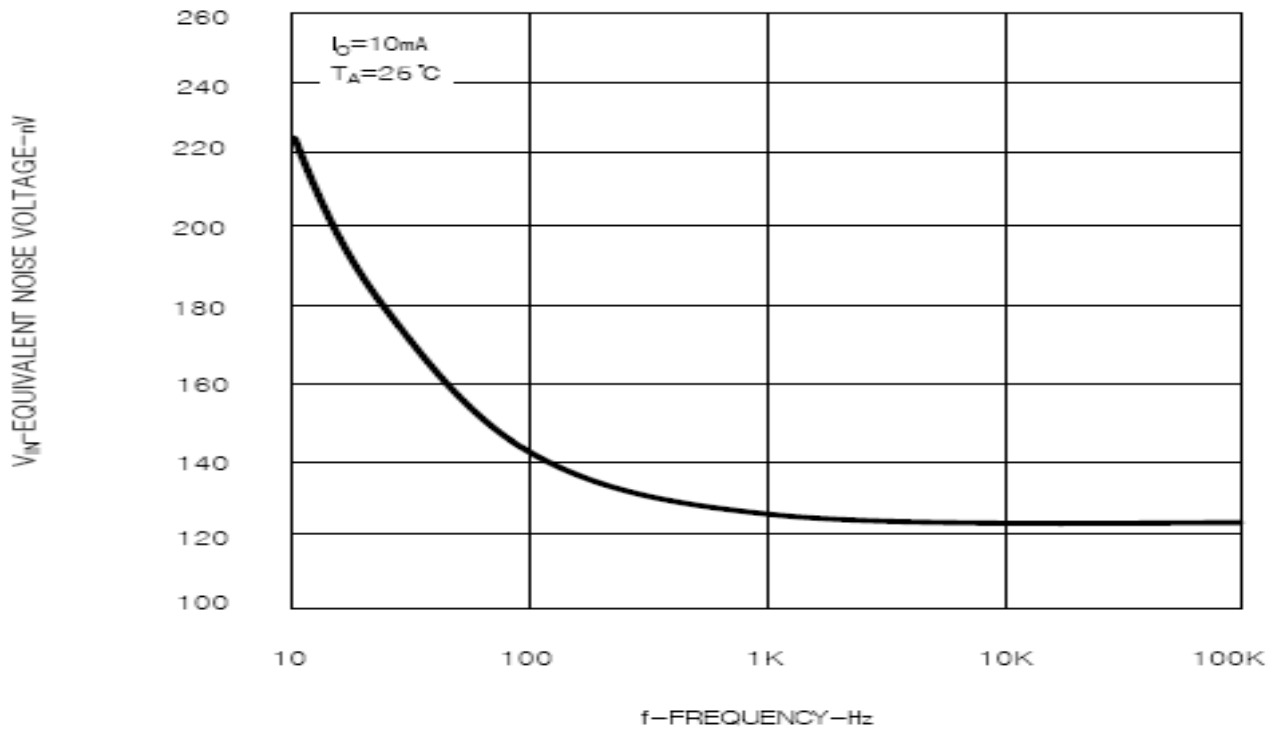
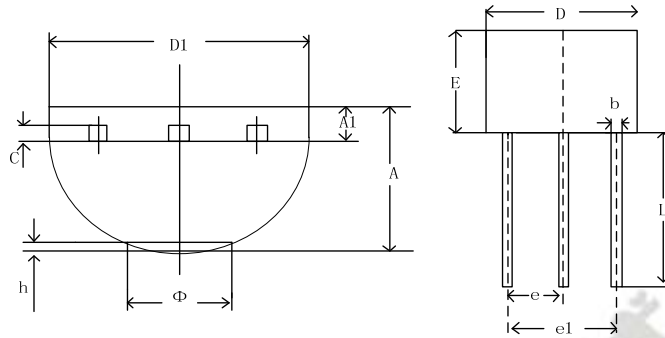

Figure 10.

Package Description

TO- 92 Package outline dimensions



Symbol	Min	In millimeters		Symbol	Min	Max
		Max	Symbol			
A	3.3	3.7	E	4.3	4.7	
A1	1.4	1.4	e	1.27TYP		
b	0.38	0.55	e1	2.44	2.64	
c	0.36	0.51	L	14.1	14.5	
D	4.4	4.7	θ		1.6	
D1	3.43		h	0.000	0.38	

SOT- 23 Package outline dimensions

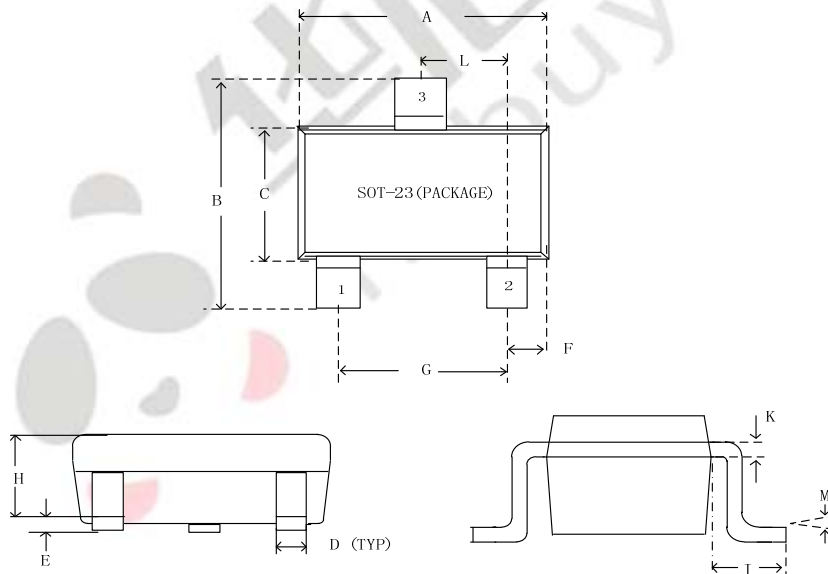

Symbol	In millimeters		Symbol	In millimeters	
	Min	Max		Min	Max
A	2.7	3.1	G	1.9REF	
B	2.4	2.8	H	1.0	1.3
C	1.4	1.6	K	0.10	0.2
D	0.35	0.5	J	0.4	--
E	0	0.1	L	0.85	1.15
F	0.45	0.55	M	0°	10°